

Article number: 60415121030

Description: Timing Belt Pulley 21 T5 30/2

## Measures

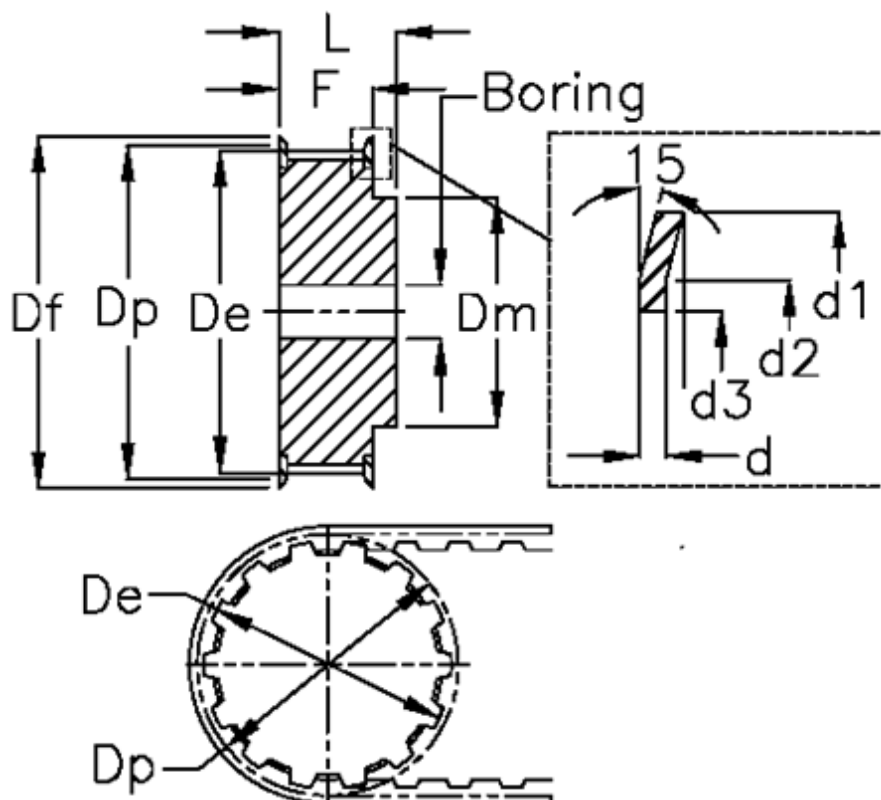

Belt width = - 10 mm	Dp	= 47.95
d = 1	F	= 15
d1 = 51	Flange type	= F19
d2 = 47	L	= 21
d3 = 40	Pre-drilled	= 8
De = 46.95	Tooth number	= 30
Df = 51	Type	= T5
Dm = 34	Weight	= 0.081